



roper co.
nuovo mobile

Roper CO.

Under the brand name Roper CO. are produced bathtubs and shower trays. Production is carried out with the most advanced technology, using raw materials of the best European manufacturers. Our bathtubs are anatomical and they are designed to fulfill the expectations of users.

The quality of raw materials and intermediate goods

The bathtubs of Roper CO. are manufactured with vacuumforming technology, using the high quality sanitary acrylic sheets. The external surface of the bathtubs is strengthened with the mixture of glass fibre and resin, reinforced with GRP where the bottom of the bathtub gets an 18 mm thick head board to improve its loadability.

Lovely for the eyes, pleasure for the body

The bathtubs have got a high glossy and smooth surface, and its touch effects a pleasurable warm feeling.

Health is the most important

This is possible by the unique hygienic treatment of the surface, which means that bacteria (microbicides) does not show growth on this surface and have no base for settling.

Simplicity of the maintenance and cleaning

The surface resists excellently against chemical materials allowing its cleaning very simple with traditional non scouring household cleaners, soft, damp cloths or sponges. On the other hand the use of aggressive and scouring chemicals like acetone, keton, ester and similar solvents are forbidden!

Continuity in quality

The bathtubs are proved within the production cycle by sparks and they are handled to water tests in order to eliminate the unvisible and hidden material defects. Our company constantly lets the quality of its bathtubs tested and proved by EU accredited institute and this way guarantees the continuity of the quality.

Warranty for bathtubs is 10 years.

Roper CO. je brend pod kojim se proizvode kade i tuš kade. Proizvodnja se obavlja najmodernijom tehnologijom, koristeći sirovine i repromaterijal najboljih evropskih proizvođača. Naše kade su anatomske i projektovane da zadovoljavaju očekivanja korisnika.

Kvalitet sirovine i repromaterijala

Roper CO. kade izrađuju se vakum tehnologijom od vrhunskih sanitarno-akrilnih ploča. Spoljni deo kade ojačan je mešavinom staklenih vlakana i veštačke smole, a dno je ojačano oplemenjenom ivericom debljine 18 mm.

Lepota za oči, užitek za telo

Površina kade je glatka i ekstra sjajna, prijatna je na dodir i daje osećaj topline.

Zdravlje je najvažnije

Higijenski tretman površine kade sprečava naseljavanje i rast bakterija.

Jednostavnost čišćenja i održavanja

Površina kade je otporna na hemikalije, te se jednostavno i lako održava čišćenjem sa klasičnim deterdžentom i mekom krpom ili sunđerom. Zabranjeno je korišćenje acetona ili sredstva koje u sebi sadrži bilo koju vrstu razređivača!

Kontinuitet u kvalitetu

Roper CO. kade se kontrolišu probnim pritiskom i prosvetljavanjem, radi otklanjanja i najmanje moguće greške u izradi. Kontinuirani kvalitet se obezbeđuje stalnom kontrolom proizvodnje uz saradnju sa evropskim akreditovanim institutom.

Garancija na kade je 10 godina.

CORNER BATHS UGAONE KADE	4
ASYMMETRICAL BATHS ASIMETRIČNE KADE	10
STRAIGHT BATHS RAVNE KADE	14
SHOWER TRAYS TUŠ KADE	22
ACCESSORIES DODATNA OPREMA	26

Corner Baths Ugaone kade



Luxus



160x160

- Optimal quantity of bathing water - 300 lit
- Optimalna količina vode za kupanje - 300 lit

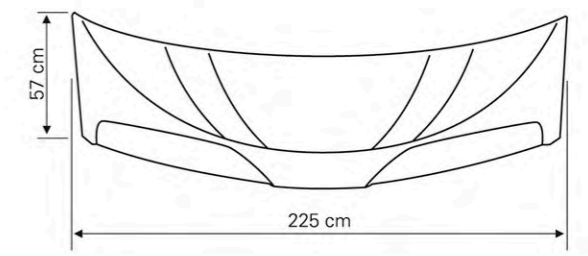
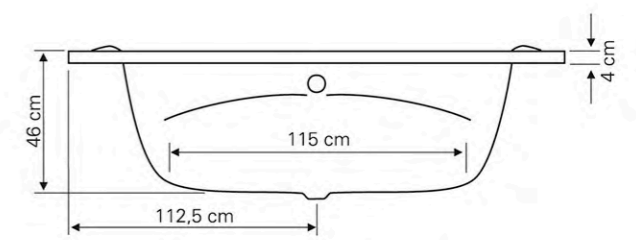
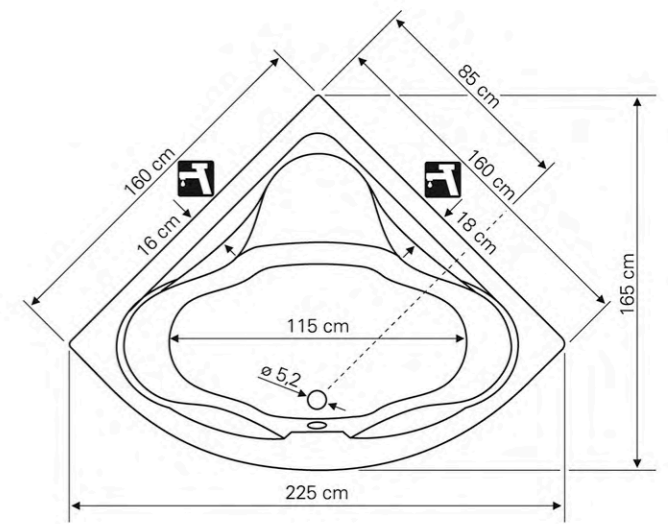

Caracas

- 150×150
- Optimal quantity of bathing water - 170 lit
 - Optimalna količina vode za kupanje - 170 lit

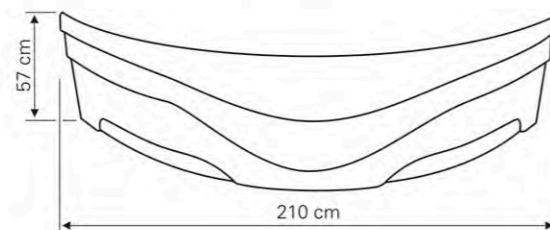
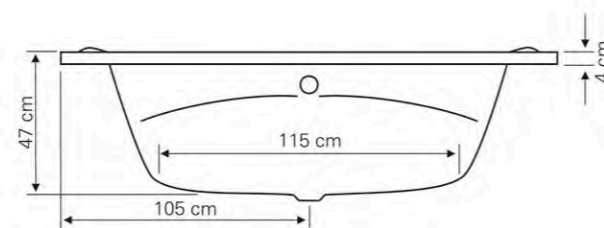
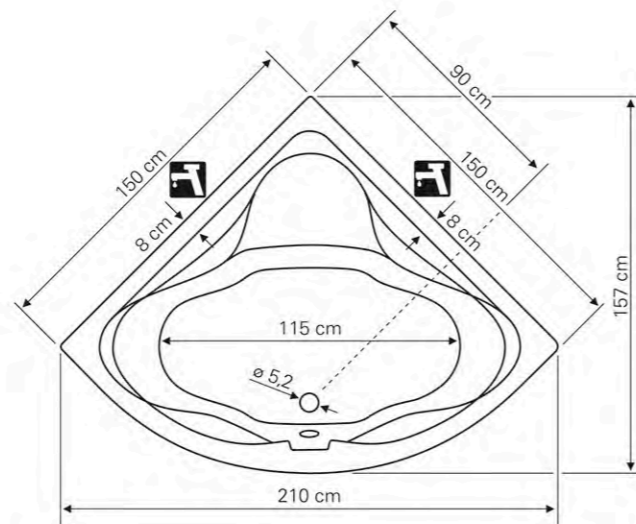

Copacabana

- 140×140
- Optimal quantity of bathing water - 150 lit
 - Optimalna količina vode za kupanje - 150 lit

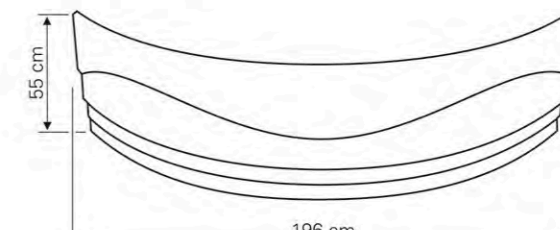
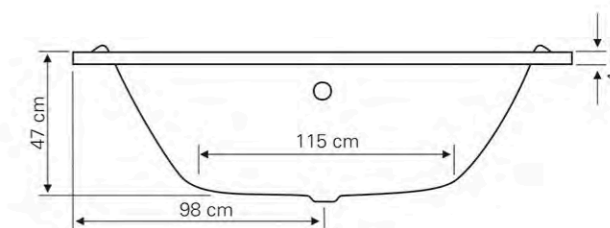
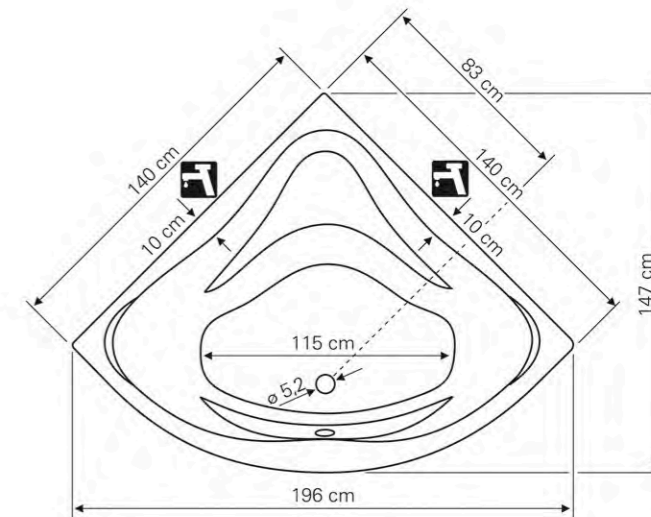

Fiji

- 140x140
- Optimal quantity of bathing water - 180 lit
 - Optimalna količina vode za kupanje - 180 lit

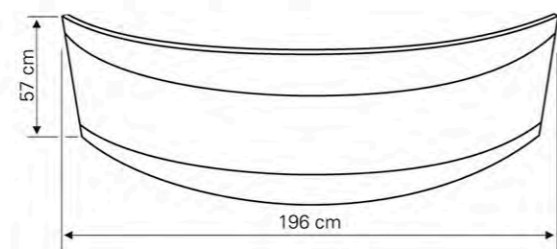
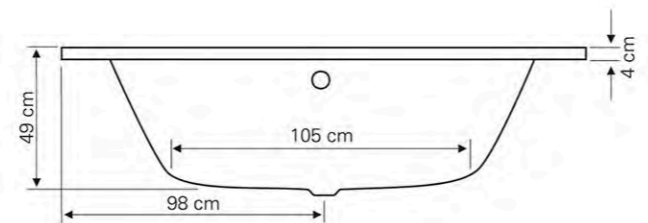
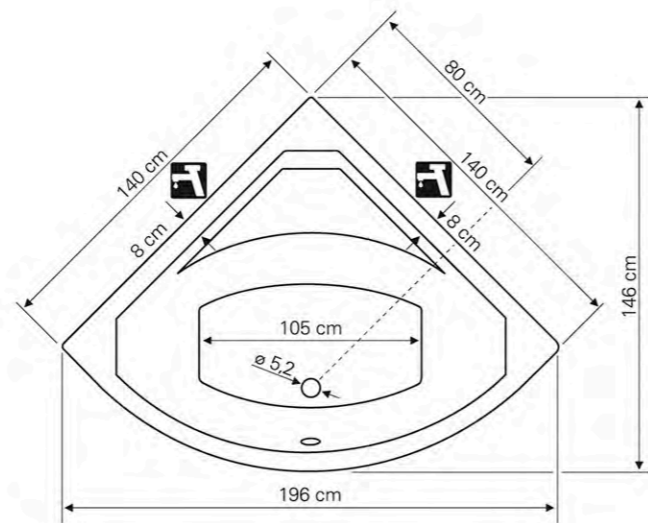

Bali

- 130x130
- Optimal quantity of bathing water - 140 lit
 - Optimalna količina vode za kupanje - 140 lit

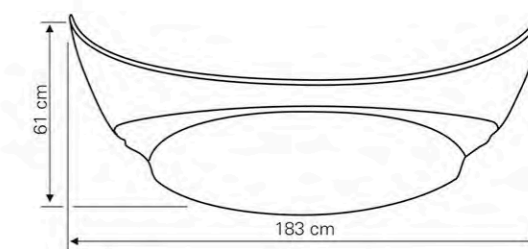
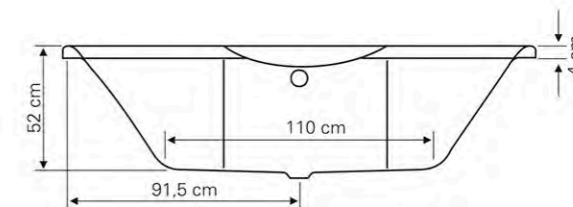
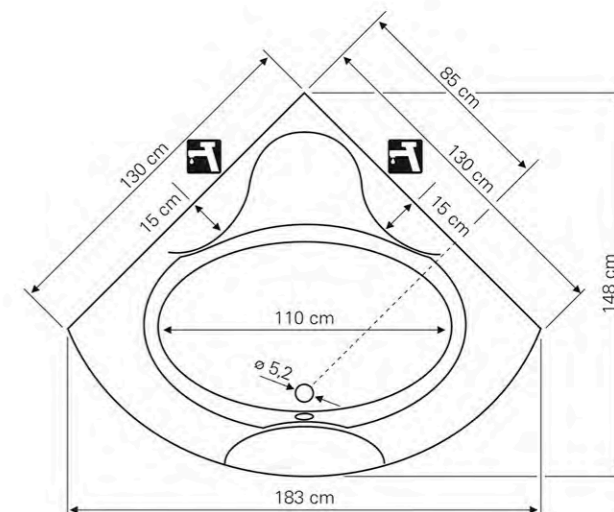
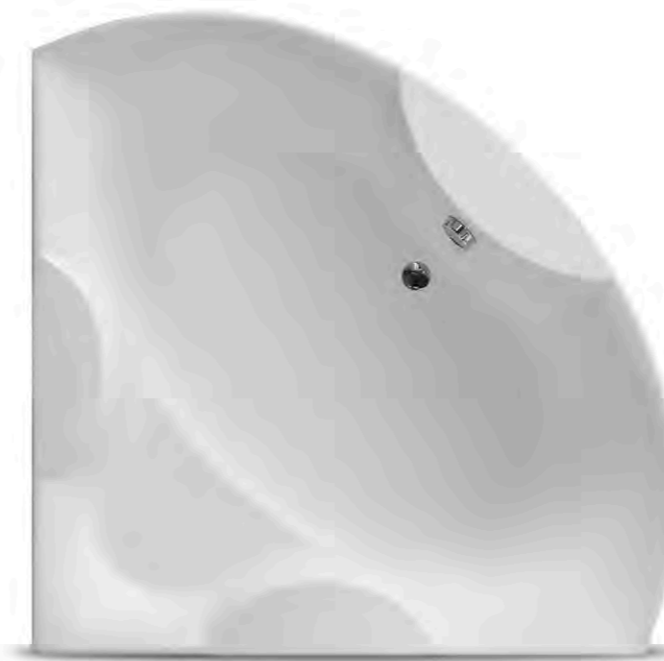

Asymmetrical Baths
Asimetrične kade



Tiffany

170×105 LBL
170×105 RJD
160×105 LBL
160×105 RJD

- Optimal quantity of bathing water
 - Optimalna količina vode za kupanje
- 170×105-170 lit • 160×105-160 lit

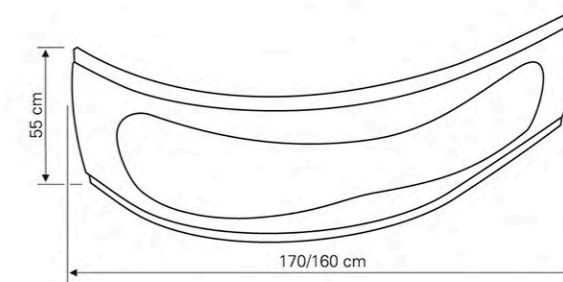
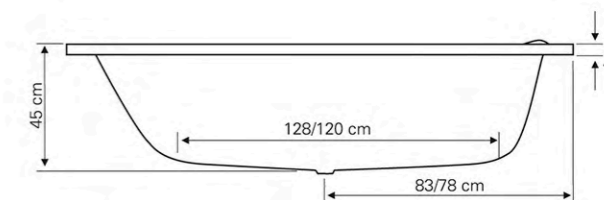
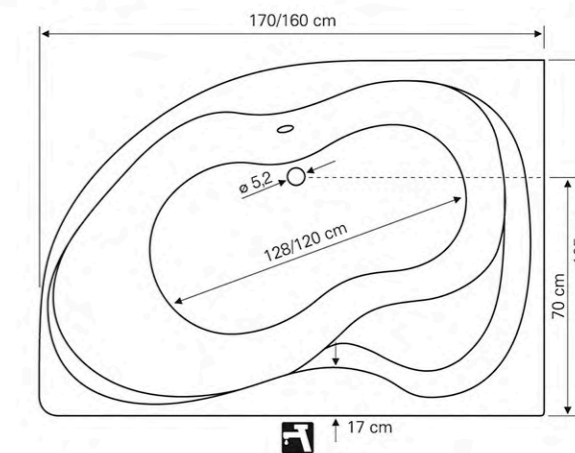

Jamaica

- 150×100 LBL • Optimal quantity of bathing water - 140 lit
- 150×100 RJD • Optimalna količina vode za kupanje - 140 lit

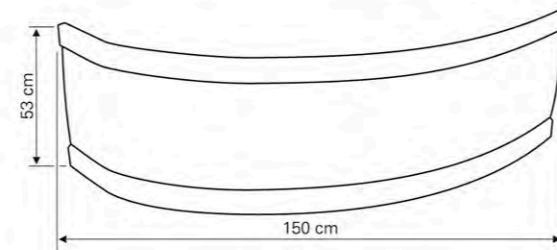
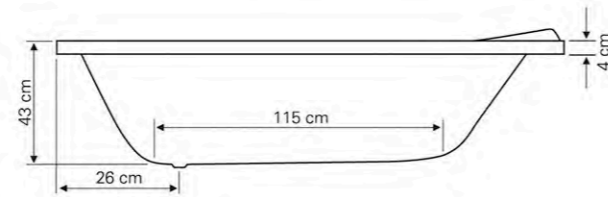
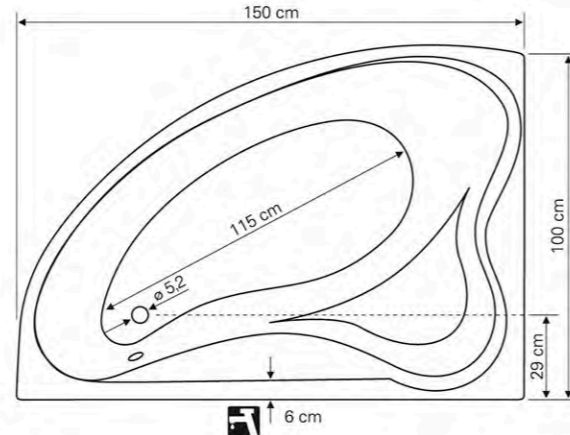

Venezia

- 160×100 LBL • Optimal quantity of bathing water - 130 lit
- 160×100 RJD • Optimalna količina vode za kupanje - 130 lit

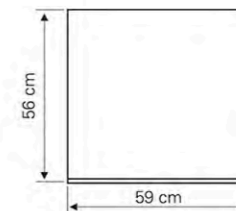
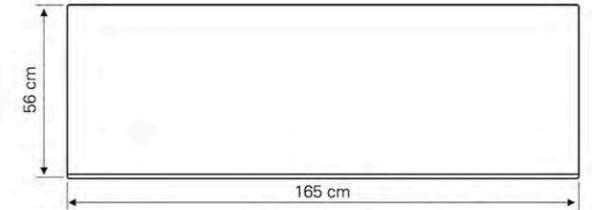
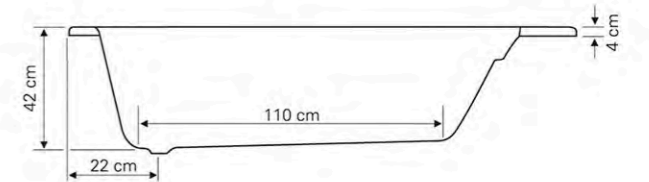
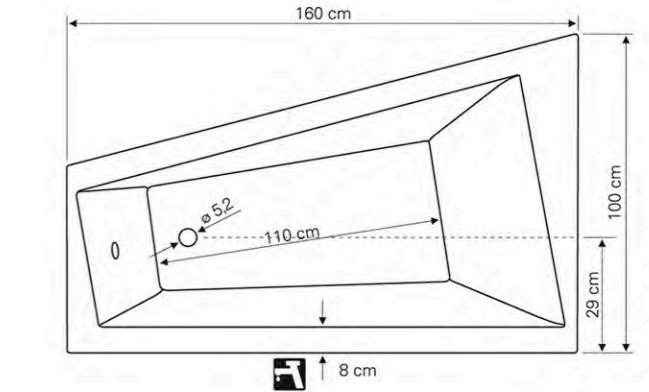

Straight Baths

Ravne kade



Lilly



140×70
120×70

- Optimal quantity of bathing water
- Optimalna količina vode za kupanje
- 140×70-70 lit • 120×70-50 lit

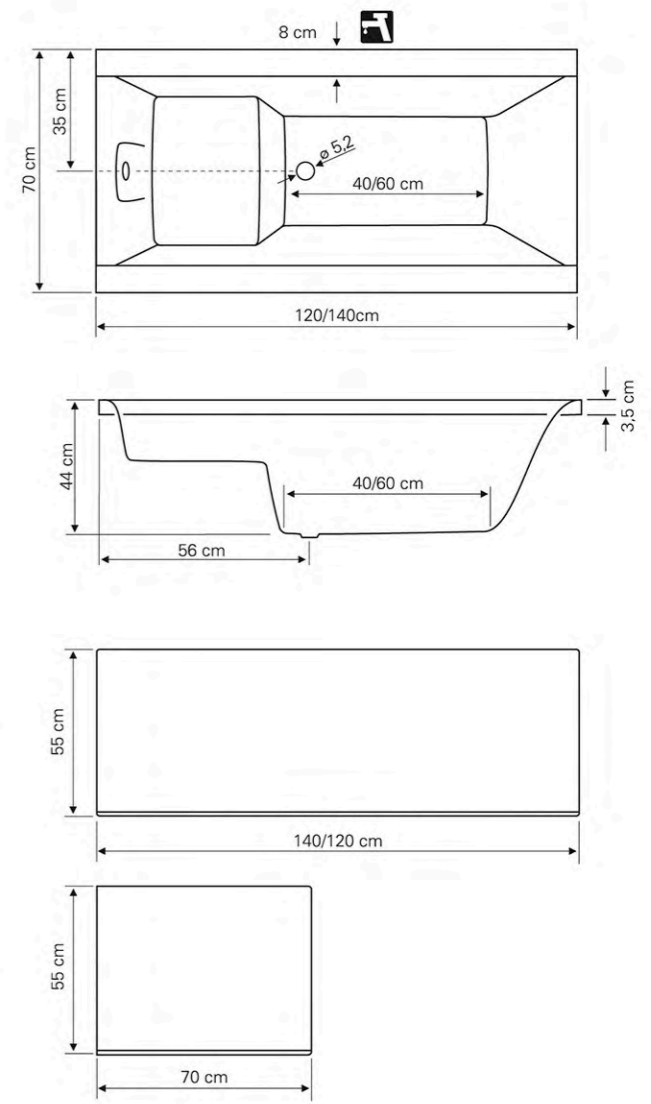

Relax

180×90

- Optimal quantity of bathing water - 150 lit
- Optimalna količina vode za kupanje - 150 lit

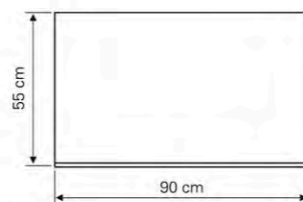
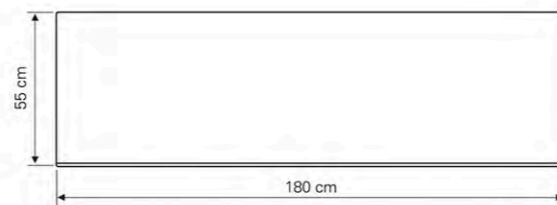
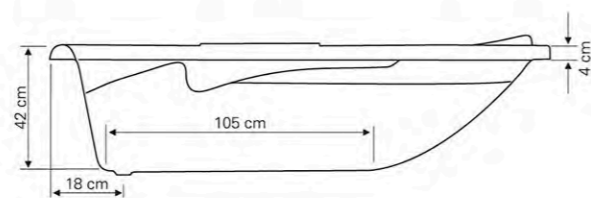
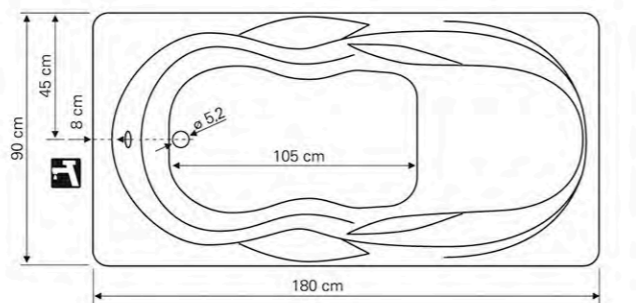

Margherita

- 180×85/75
- Optimal quantity of bathing water - 190 lit
 - Optimalna količina vode za kupanje - 190 lit

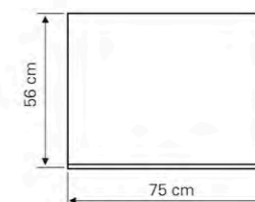
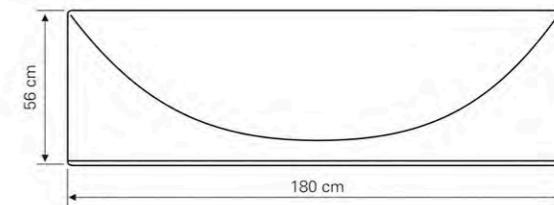
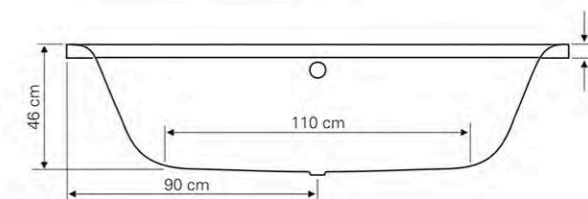
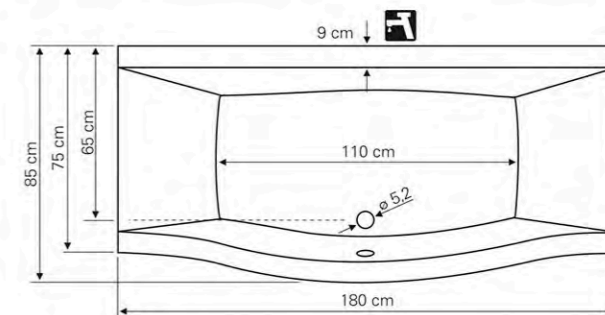

Normandia Duo

180×80
170×75

- Optimal quantity of bathing water
- Optimalna količina vode za kupanje
180×80-150 lit • 170×75-130 lit

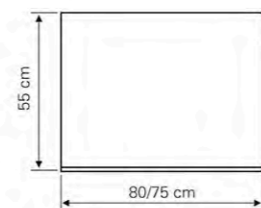
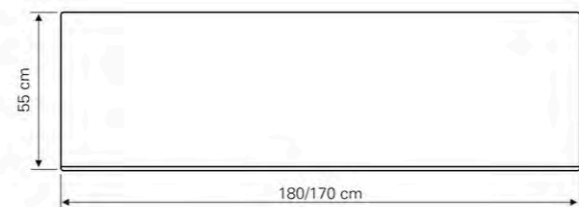
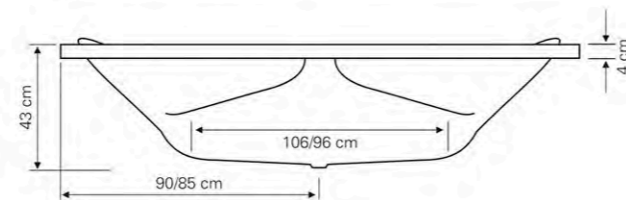
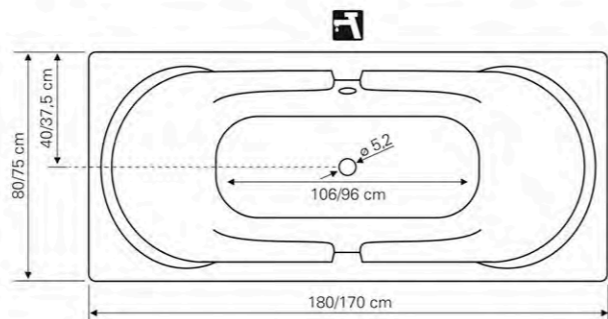

Normandia

170×70
160×70
150×70
140×70

- Optimal quantity of bathing water
- Optimalna količina vode za kupanje
170×70-120 lit • 160×70-110 lit
150×70-100 lit • 140×70-90 lit

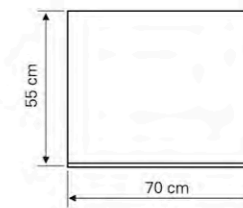
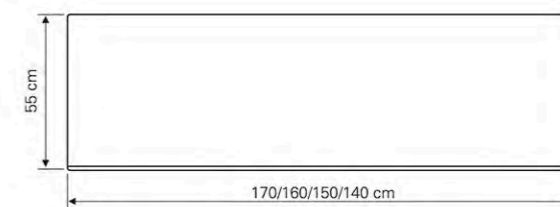
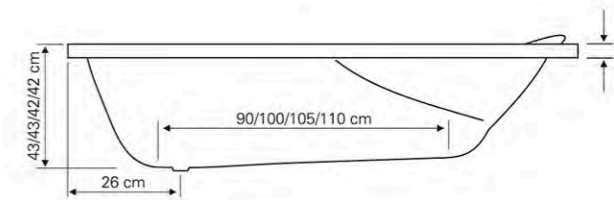
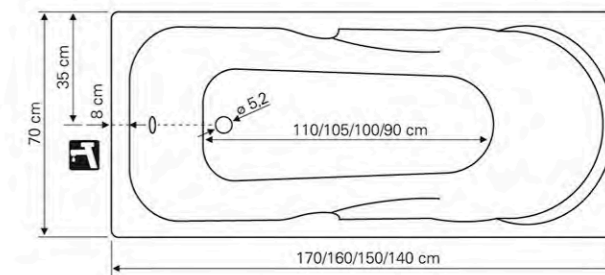

Pamela

- Optimal quantity of bathing water
- Optimalna količina vode za kupanje
- 170×70-110 lit • 160×70-100 lit • 150×70-90 lit
- 140×70-80 lit • 120×70-60 lit

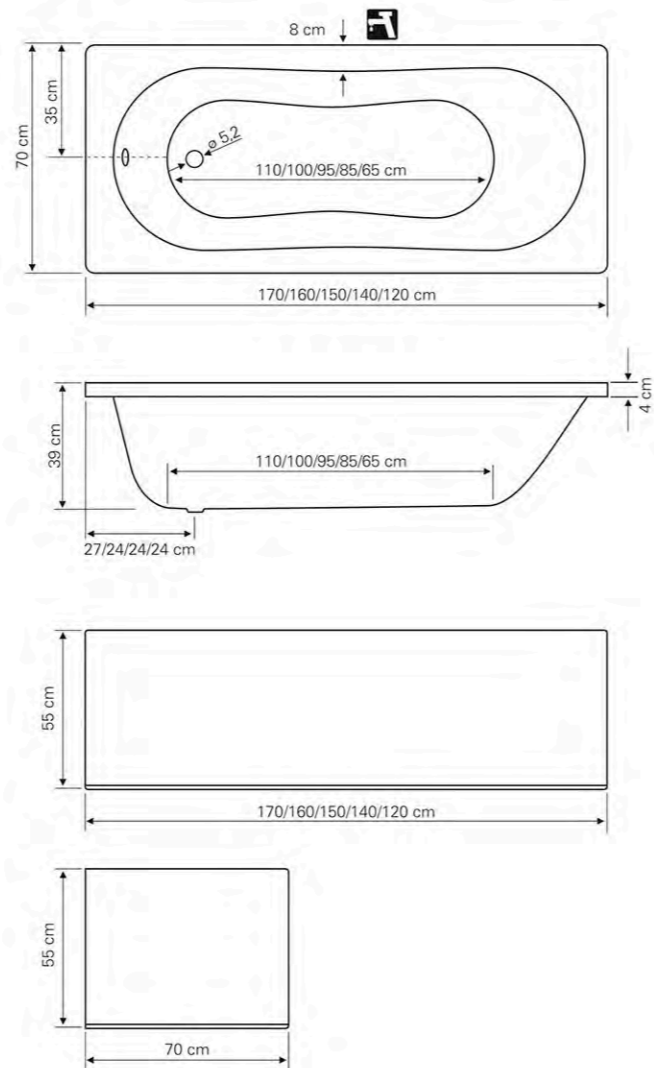

Jasmin

- Optimal quantity of bathing water
- Optimalna količina vode za kupanje
- 170×75-140 lit • 160×75-130 lit • 150×70-120 lit
- 140×70-110 lit • 120×70-100 lit

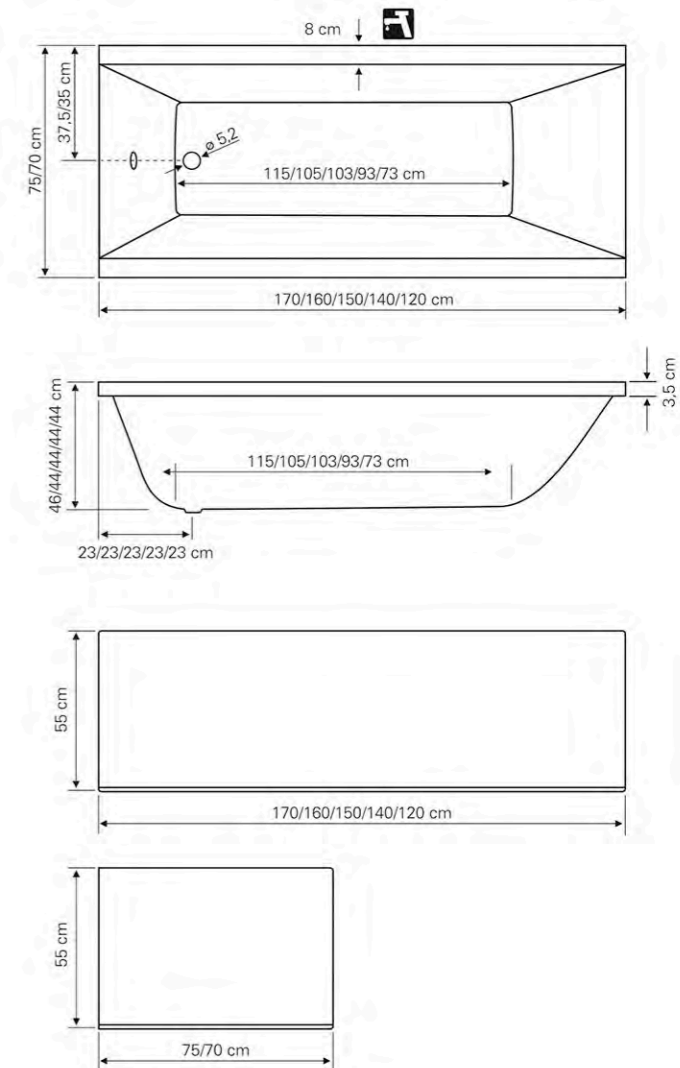

Shower Trays

Čouš kade



Malta



R-90
R-80

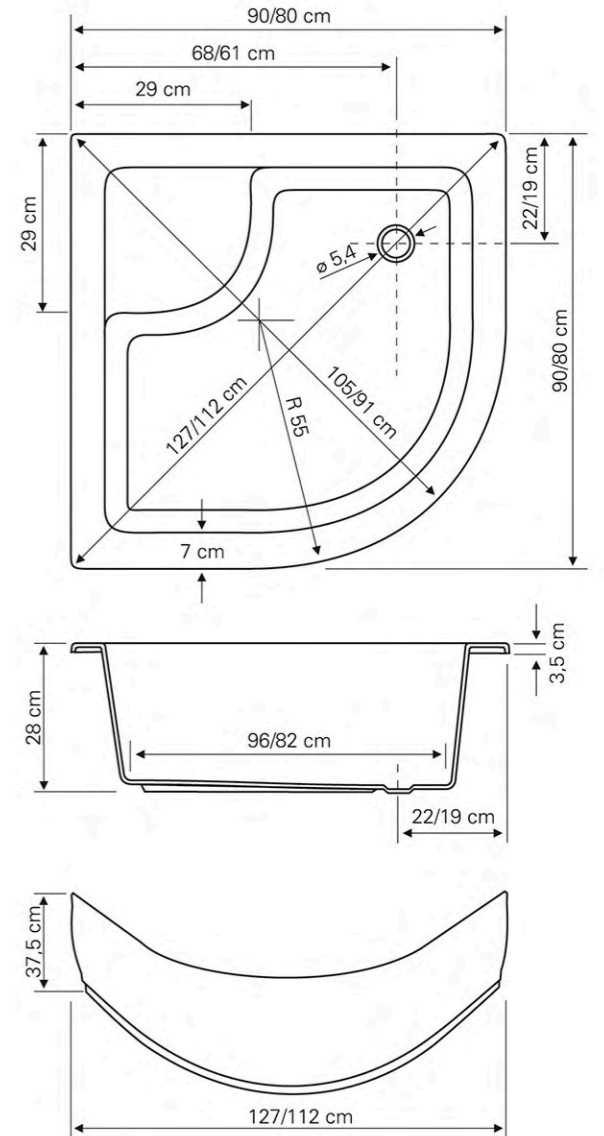

Fisa / Fonte

90×90
80×80

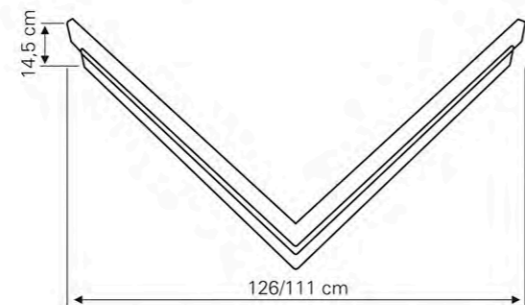
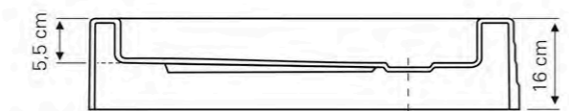
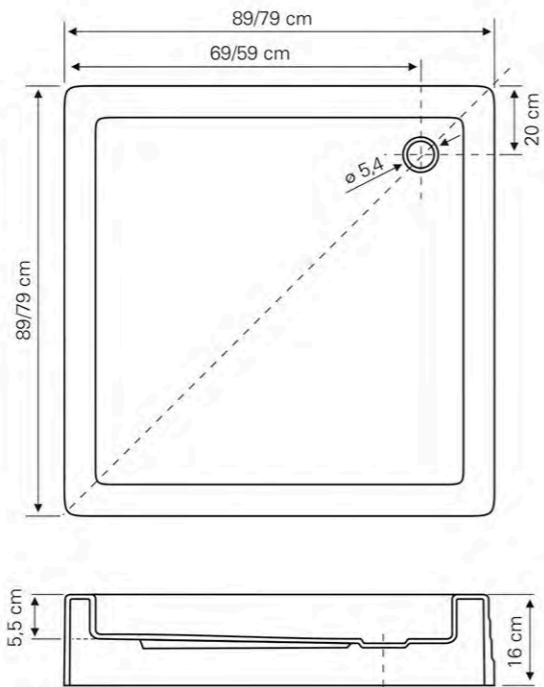

Fisa

Fonte



R-90
R-80

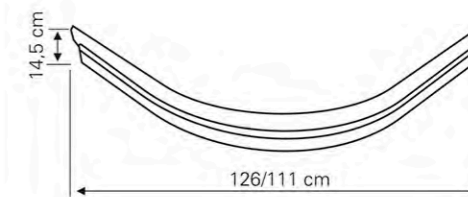
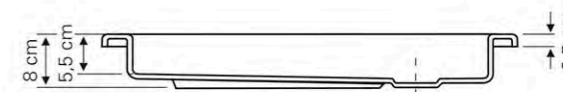
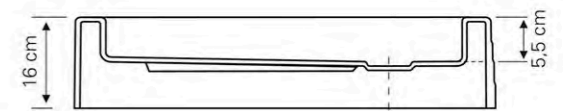
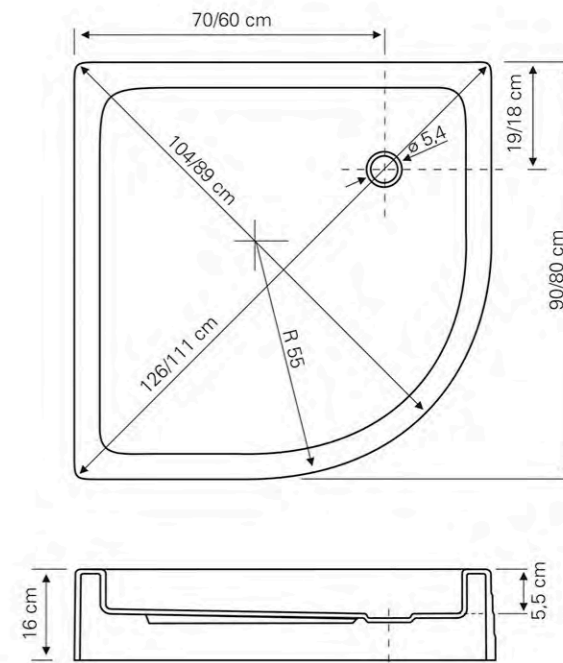

Fisa

Fonte



LUX FRAMEWORK • LUX PODKONSTRUKCIJA



LPN



LPU

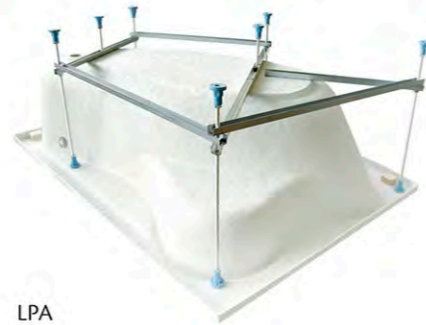

LPA

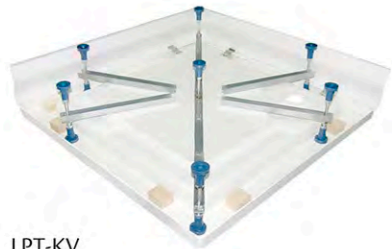

LPT-KV

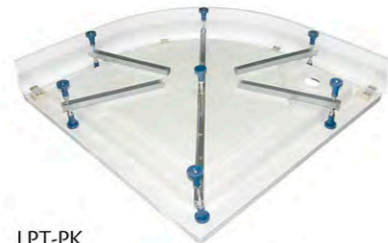

LPT-PK



LPT-PKD

LEVELING LEGS • NOŽICE ZA NIVELACIJU KADA



600



600



600/800

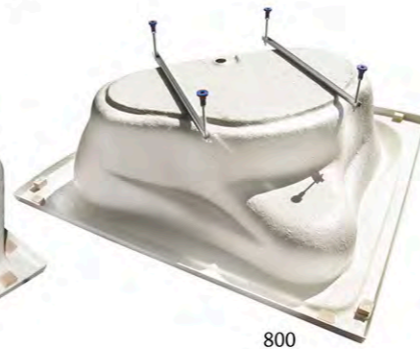

800

Series of horizontal lines for taking notes.

roper co.
nuovo mobile

Bathtub factory - Fabrika kada:
SERBIA - 24420 Kanjiža
Put narodnih heroja 10.
Tel/fax: +381 (0)24 874-161

Karadorđeva 113a
11260 Umka | Beograd | Srbija
Tel. | Fax +381 11 8025 654
+381 11 8026 456

roper@emnongroup.com

www.roper.co.rs