



Bathtubs

Kade za kupanje
2016

roper co.
nuovo mobile



roper co.

nuovo mobile

Under the brand name **Roper co** are produced bathtubs and shower trays. Production is carried out with the most advanced technology, using raw materials of the best European manufacturers. Our bathtubs are anatomical and they are designed to fulfill the expectations of users.

The quality of raw materials and intermediate goods

The bathtubs of **Roper co** are manufactured with vacuumforming technology, using the high quality sanitary acrylic sheets.

The external surface of the bathtubs is strengthened with the mixture of glass fibre and resin, reinforced with GRP where the bottom of the bathtub gets an 18 mm thick head board to improve its loadability.

Lovely for the eyes, pleasure for the body

The bathtubs have got a high glossy and smooth surface, and its touch effects a pleasurable warm feeling.

Health is the most important

This is possible by the unique hygienic treatment of the surface, which means that bacteria (microbicides) does not show growth on this surface and have no base for settling.

Simplicity of the maintenance and cleaning

The surface resists excellently against chemical materials allowing its cleaning very simple with traditional non scouring household cleaners, soft, damp cloths or sponges. On the other hand the use of aggressive and scouring chemicals like acetone, keton, ester and similar solvents are forbidden!

Warranty for bathtubs is 5 years.

Roper co je brend pod kojim se proizvode kade i tuš kade. Proizvodnja se obavlja najmodernijom tehnologijom, koristeći sirovine i repromaterijal najboljih evropskih proizvođača. Naše kade su anatomske i projektovane da zadovoljavaju očekivanja korisnika.

Kvalitet sirovine i repromaterijala

Roper co kade izrađuju se vakum tehnologijom od vrhunskih sanitarno-akrilnih ploča.

Spoljni deo kade ojačan je mešavinom staklenih vlakana i veštačke smole, a dno je ojačano oplemenjenom ivericom debljine 18 mm.

Lepota za oči, užitak za telo

Površina kade je glatka i ekstra sjajna, prijatna je na dodir i daje osećaj topline.

Zdravlje je najvažnije

Higijenski tretman površine kade sprečava naseljavanje i rast bakterija.

Jednostavnost čišćenja i održavanja

Površina kade je otporna na hemikalije, te se jednostavno i lako održava čišćenjem sa klasičnim deterdžentom i mekom krpom ili sunderom.

Zabranjeno je korišćenje acetona ili sredstva koje u sebi sadrži bilo koju vrstu razređivača!

Garancija na kade je 5 godina.



STANDARDNE KADE
BASIC BATHTUBE

UGAONE KADE
CORNER BATHTUBE

TUŠ KADE
SHOWER TRAYS

TEHNIČKI PODACI
TECHNICAL DATA

DODATNA OPREMA
ACCESSORIES

Jasmin

Normandia



170x75
160x75
150x70
140x70
120x70

Jasmin



170x70
160x70
150x70
140x70

Normandia



Normandia duo

180×80

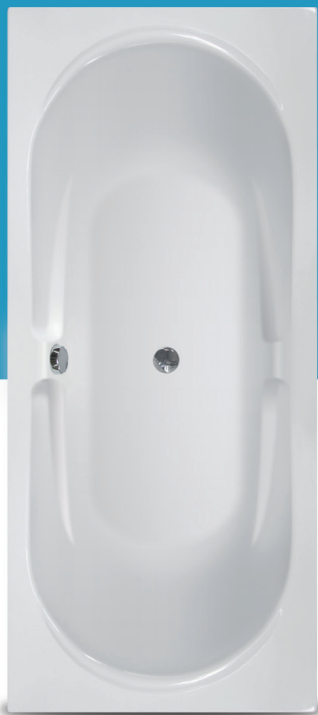

Normandia
duo



Pamela

170×70
160×70
150×70
140×70
120×70



Pamela



Jamaica

150×100



Bali

130×130



Jamaica



Bali



Caracas

150×150



Copacabana

140×140



Caracas



Copacabana



Tiffany

170-160x100
L/D



Tiffany



Venezia

160x100
L/D



Venezia



Malta

Tisa / Fonte

R-90
R-80

90×90
80×80



R-90
R-80



Malta

Tisa Fonte



Jasmin

Normandia

Normandia duo

170×75 150×70
160×75 140×70
120×70

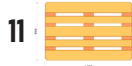

170×70 150×70
160×70 140×70



180×80



Bathtub - Kada

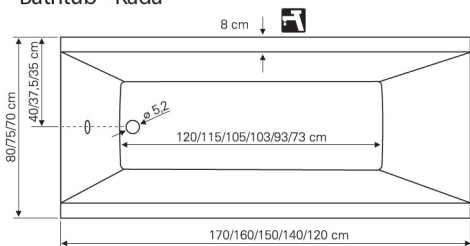

Bathtub - Kada

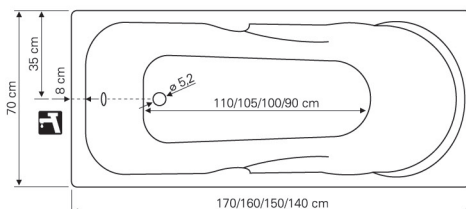

Bathtub - Kada

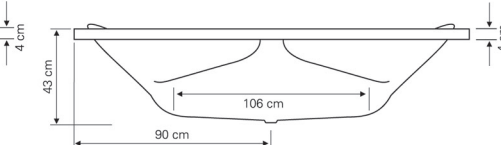
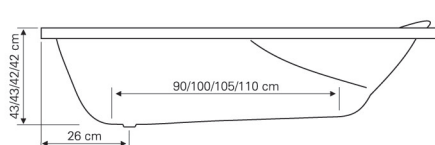
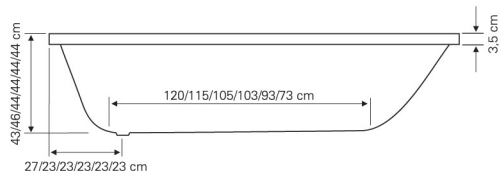
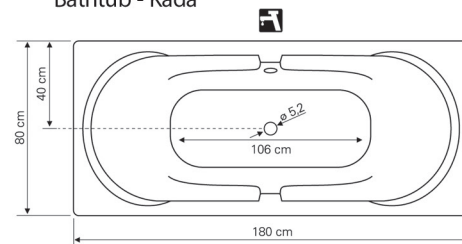

- Optimal quantity of bathing water
- Optimalna količina vode za kupanje
- 170×75-140 lit • 160×75-130 lit
- 150×70-120 lit • 140×70-110 lit • 120×70-100 lit

- Optimal quantity of bathing water
- Optimalna količina vode za kupanje
- 170×70-120 lit • 160×70-110 lit
- 150×70-100 lit • 140×70-90 lit

- Optimal quantity of bathing water - 130 lit
- Optimalna količina vode za kupanje - 130 lit

Front panel - Prednja obloga

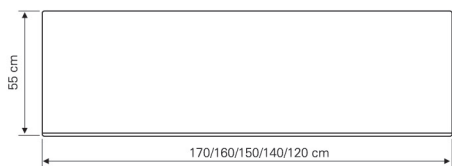

Front panel - Prednja obloga

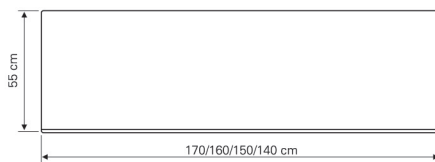

Front panel - Prednja obloga

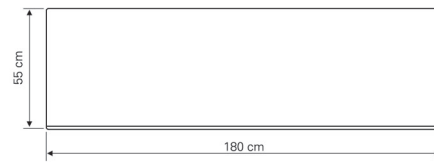

Side panel - Bočna obloga

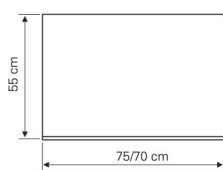

Side panel - Bočna obloga

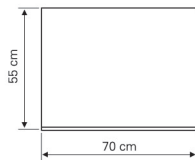

Side panel - Bočna obloga

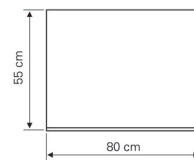

Pamela

Jamaica

170×70 140×70
160×70 120×70
150×70

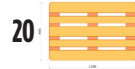

Bat.htub - Kada

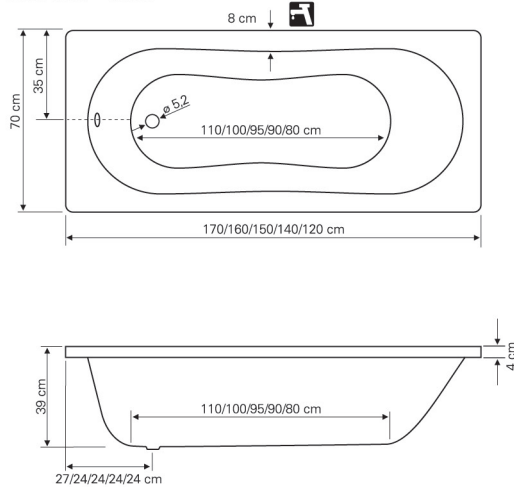

- Optimal quantity of bathing water
 - Optimalna količina vode za kupanje
- 170×70-110 lit • 160×70-100 lit • 150×70-90 lit
140×70-80 lit • 120×70-60 lit

Front panel - Prednja obloga

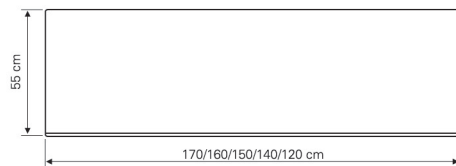

Side panel - Bočna obloga

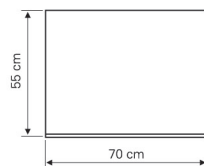

150×100



Bathtub - Kada

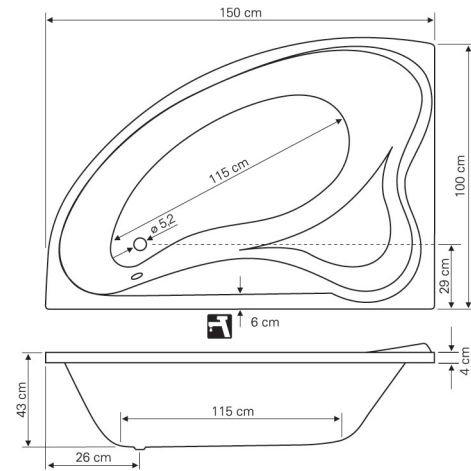

- Optimal quantity of bathing water - 140 lit
- Optimalna količina vode za kupanje - 140 lit

Front panel - Prednja obloga

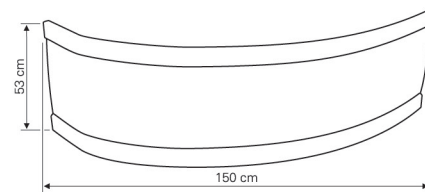

Bali

Caracas

Copacabana

130x130

11

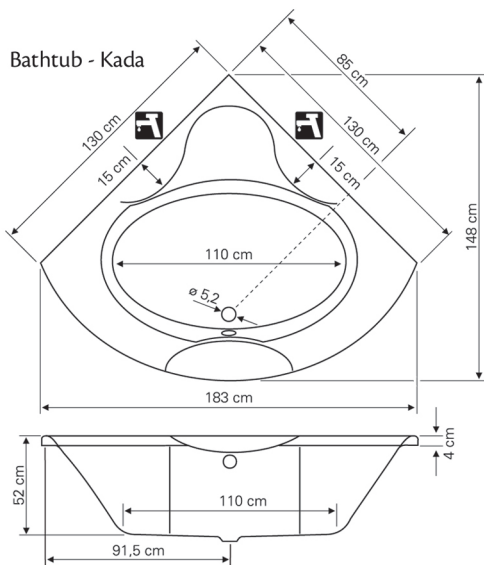

150x150

11

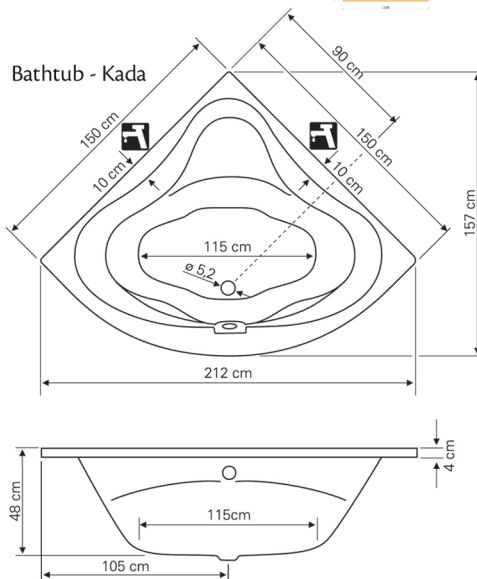

140x140

11

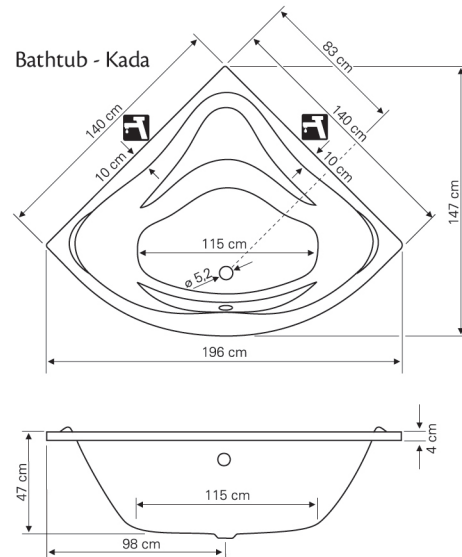

- Optimal quantity of bathing water - 150 lit
- Optimalna količina vode za kupanje - 150 lit

Front panel - Prednja obloga

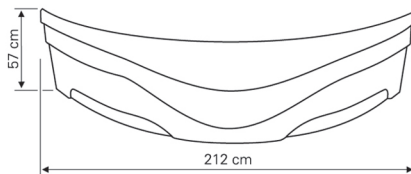
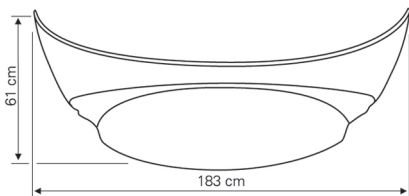

Front panel - Prednja obloga

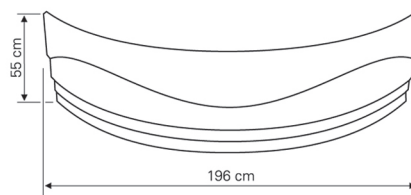
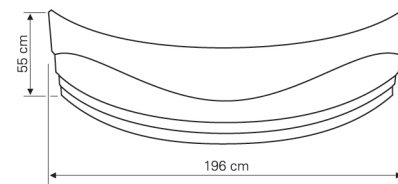

Tiffany

Venezia

170-160x105



Bathtub - Kada

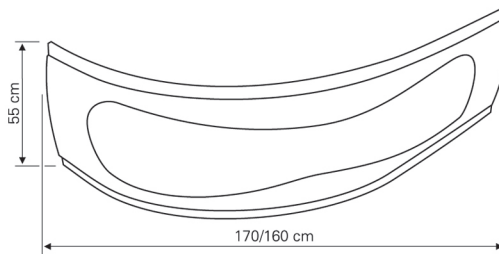
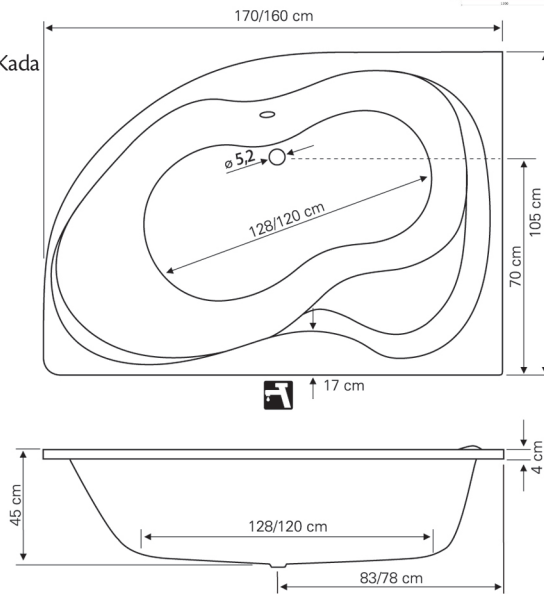

160x100



Bathtub - Kada

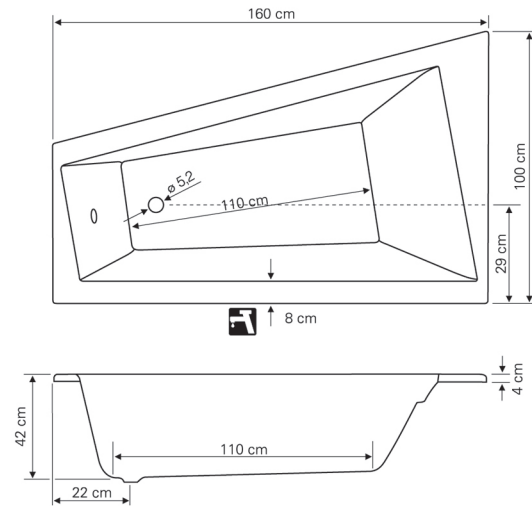

Front panel - Prednja obloga

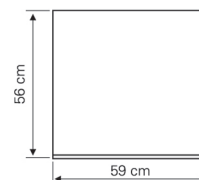
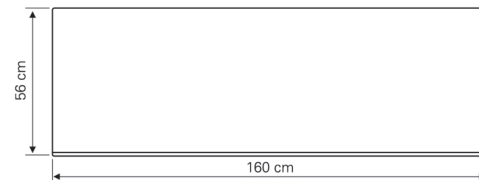

Malta

Tisa

R-90
R-80

20



90×90
80×80

Shower tray - Tuš kada

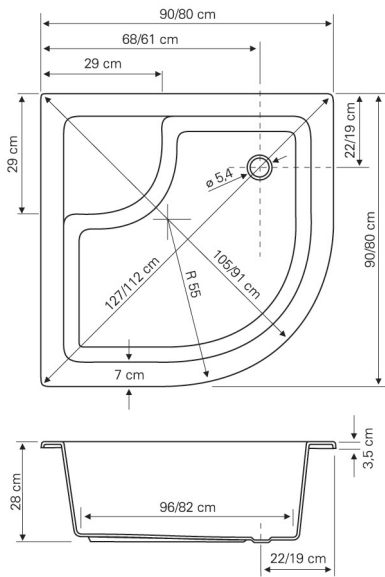

Front panel - Prednja obloga

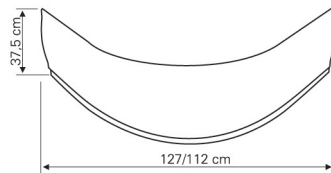

Shower tray - Tuš kada

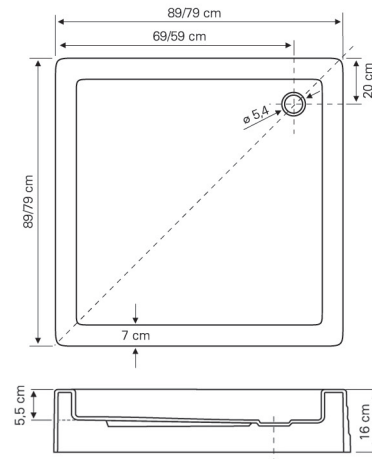

90×90
80×80



Front panel - Prednja obloga

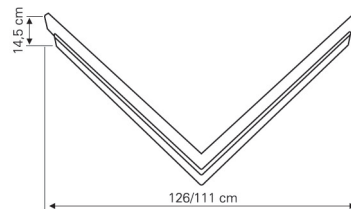

R-90
R-80

10



Shower tray - Tuš kada

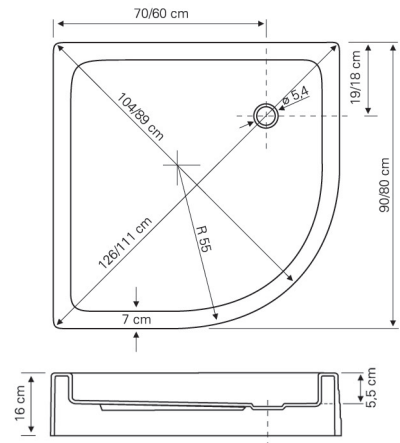

R-90
R-80



Front panel - Prednja obloga

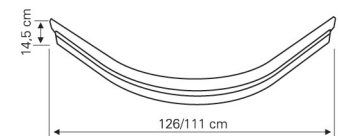

Fonte

10



Accessories - Dodatna oprema

LUX FRAMEWORK ♦ LUX PODKONSTRUKCIJA

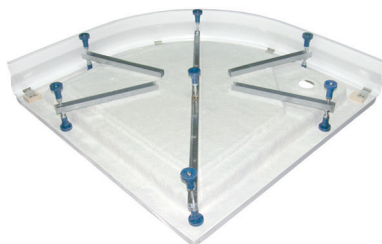
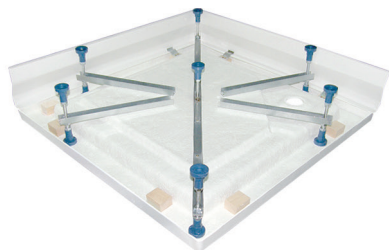
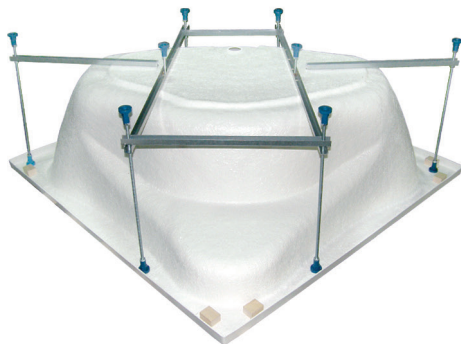
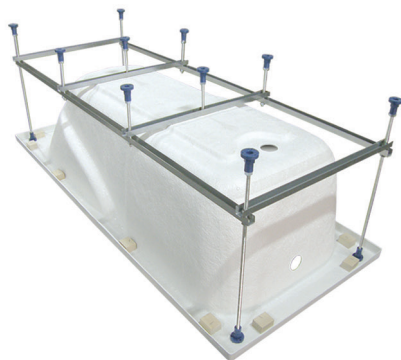

LEVELING LEGS ♦ NOŽICE ZA NIVELACIJU KADA



600

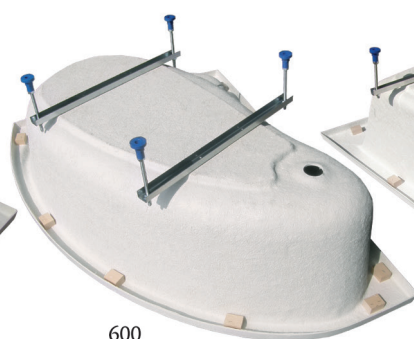

600

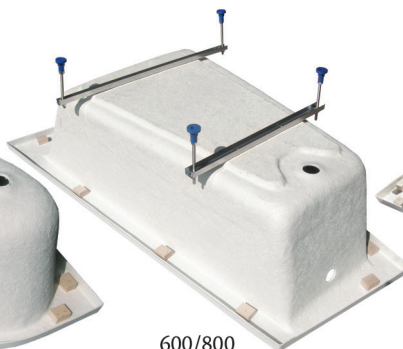

600/800

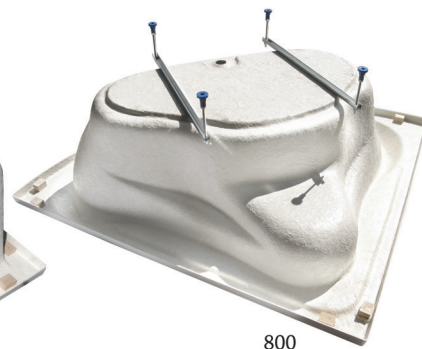

800

roper co.
nuovo mobile

Bathtub factory - Fabrika kada:

SERBIA - 24420 Kanjiža
Put Narodnih Heroja 10
Tel/fax: +381 (0)24 874-161

Karadorđeva 113a
11260 Umka | Beograd | Srbija
Tel. | Fax +381 11 8025 654
+381 11 8026 456

roper@enmongroup.com

www.roper.co.rs